



Add-On Products

# Resource Central

---

## Installation Guide

**For RC 4.2**

**Document Revision 03**

Add-On Products  
Roms Hule 8 – 7100 Vejle – Denmark  
Phone: +45 7944 7000 Fax: +45 7944 7001

Mail: [info@add-on.com](mailto:info@add-on.com)  
Internet: [www.add-on.com](http://www.add-on.com)



No parts of this publication may be reproduced in any form or by any means or used to make any derivative such as translation, transformation, or adaptation without the permission from Add-On Products.



# Table of contents

---

Table of contents .....	2
CHAPTER 1.	3
Introduction.....	3
Resource Central Overview .....	3
Resource Central components .....	5
CHAPTER 2.	7
Installation .....	7
Prepare for installation .....	7
Install Web Application.....	7
Configure Web Application.....	7
Install and configure Add-in.....	7
CHAPTER 3.	8
Appendices.....	8
Appendix A: Rights for installation of RC web application/Add-in .....	8
Appendix B: Step-by-step installation of RC Web Application .....	8
Appendix C: Web Application configuration .....	12
Appendix D: Configure Single Sign-On using Windows Authentication .....	16
Appendix E: RC Digital Signage Export settings.....	17
Appendix F: Twain configuration .....	28
Appendix G: Uninstallation .....	31
Appendix H: Configure Single Sign-On (SSO) for RC Outlook Add-In.....	31

## CHAPTER 1. Introduction

Resource Central is one of the products of Add-On Products for resource management, partnering with Microsoft Outlook and the Exchange Server, which are bridged by RTS (refer to **RealTime Service User Guide** for more details). This product helps organizations to define, manage and maintain their resources even on distinct geographical locations. It also provides an integrated solution for authorized users to arrange meetings and events along with extra service orders through a customizable and user friendly interface and then track the status of orders.

The Resource Central Installation guide describes the complete procedure for a successful deployment of the Resource Central application. We will discuss the installation procedures for each module, along with the pre-requisites, if required, as well as the post installation setup.

### Resource Central Overview

Major interface components in this product are as follows:

- Resource Central Add-in interface for organizers.
- Resource Central Admin interface for system administrators.
- Resource Central Manager interface for system managers.

Apart from these, the product includes a Windows Service called Digital Signage Export which facilitates the integration of Resource Central with external systems.

Following diagrams describe the overall interaction of Resource Central with other stakeholders.

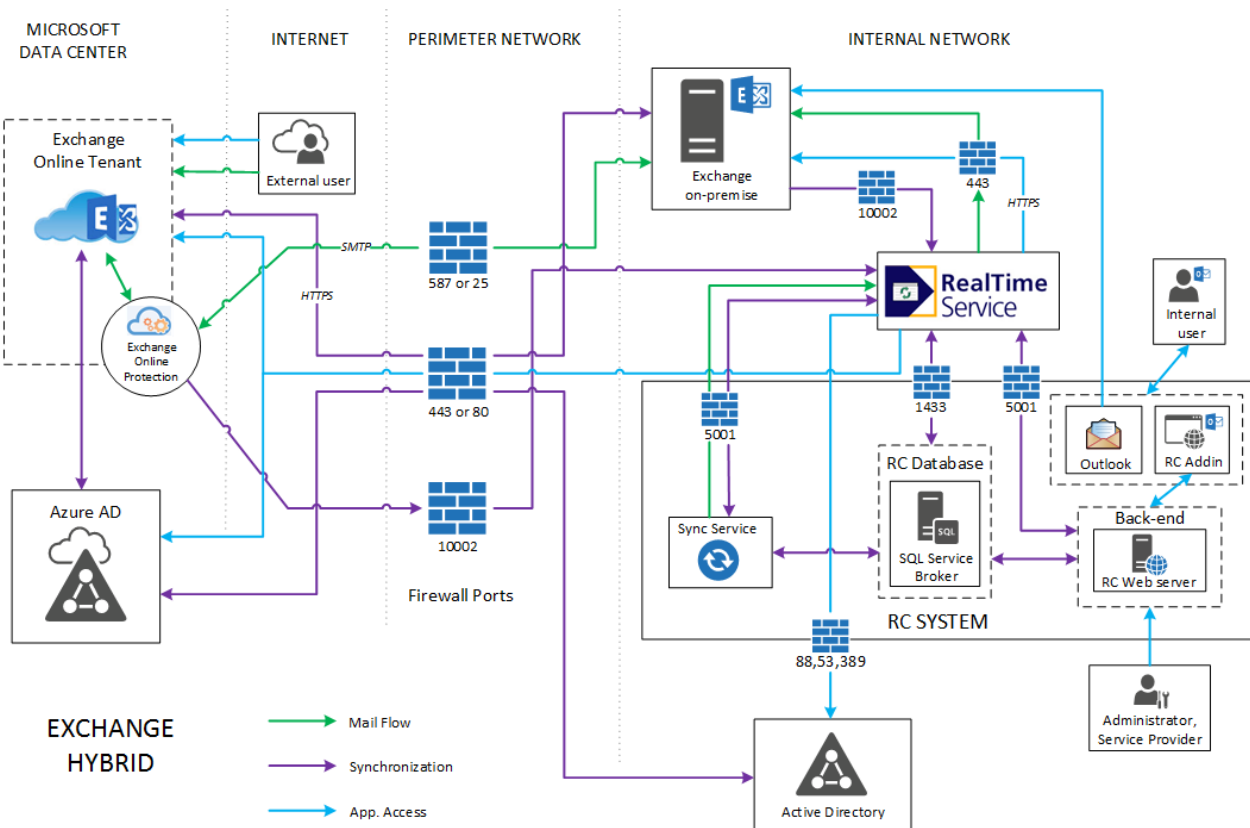


Figure 1. RC Diagram (Exchange Hybrid)

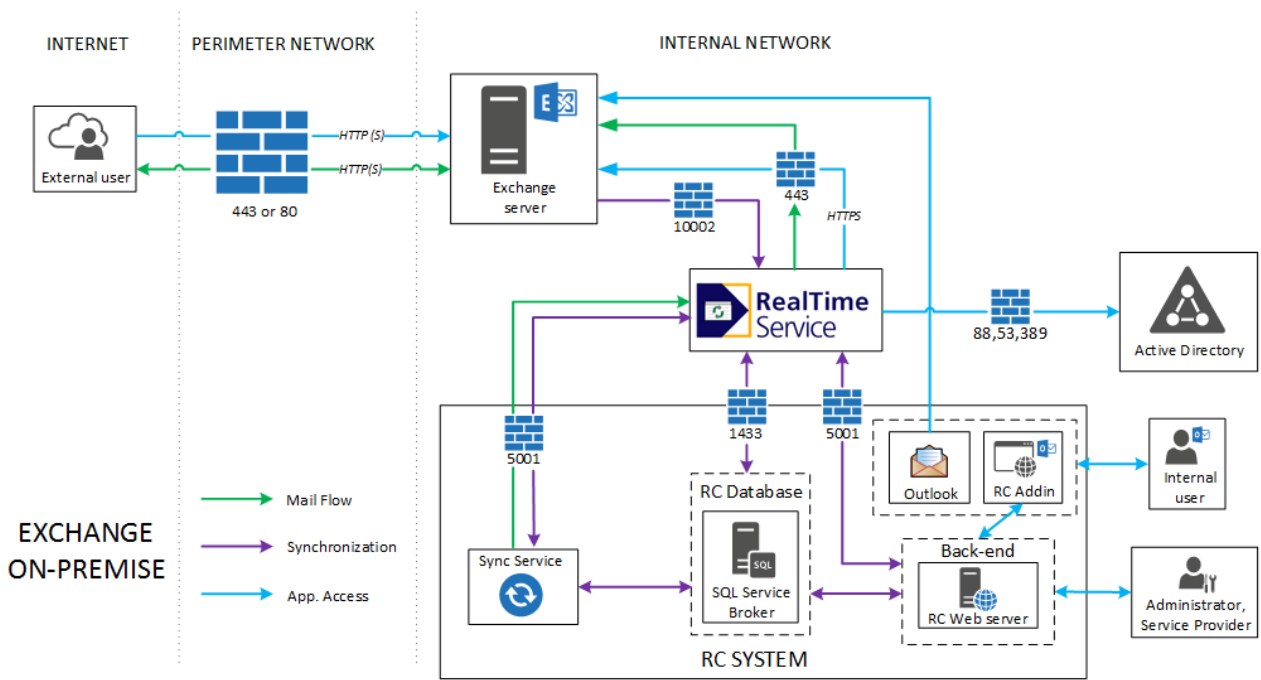


Figure 2. RC Diagram (Exchange On-Premise)

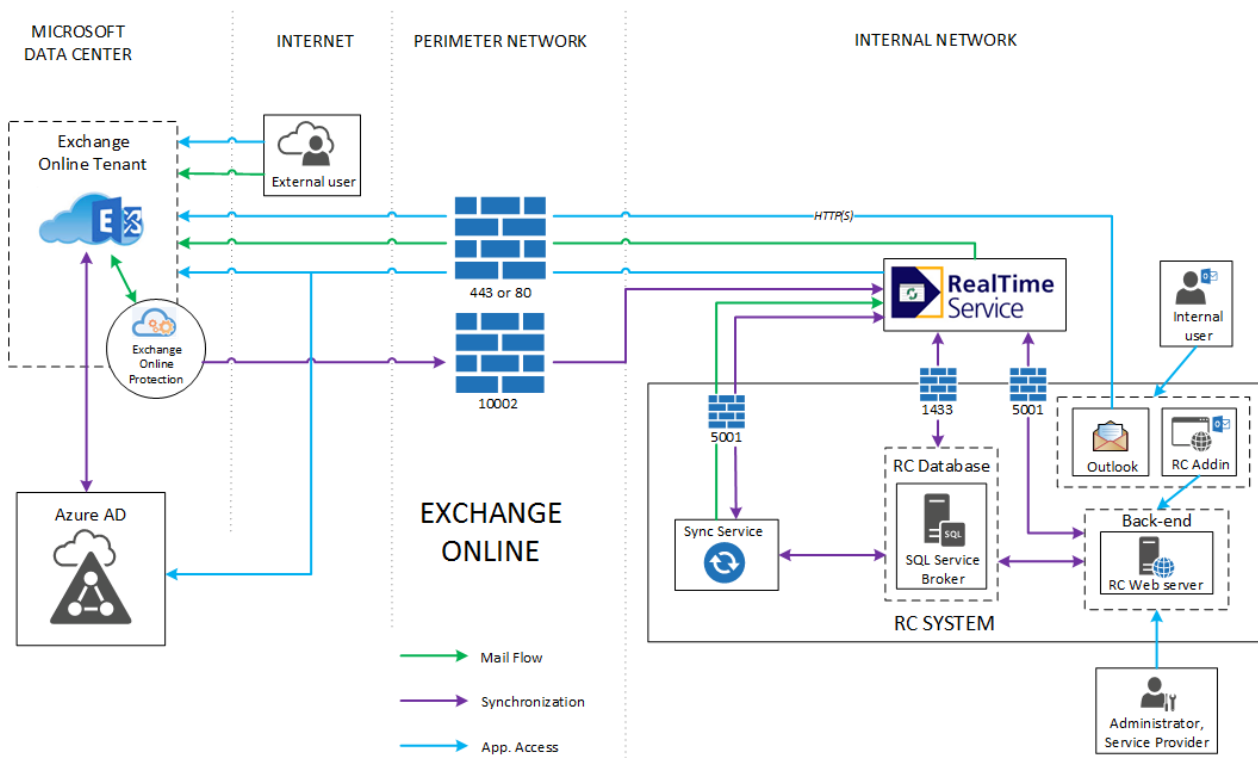


Figure 3. RC Diagram (Exchange Online)

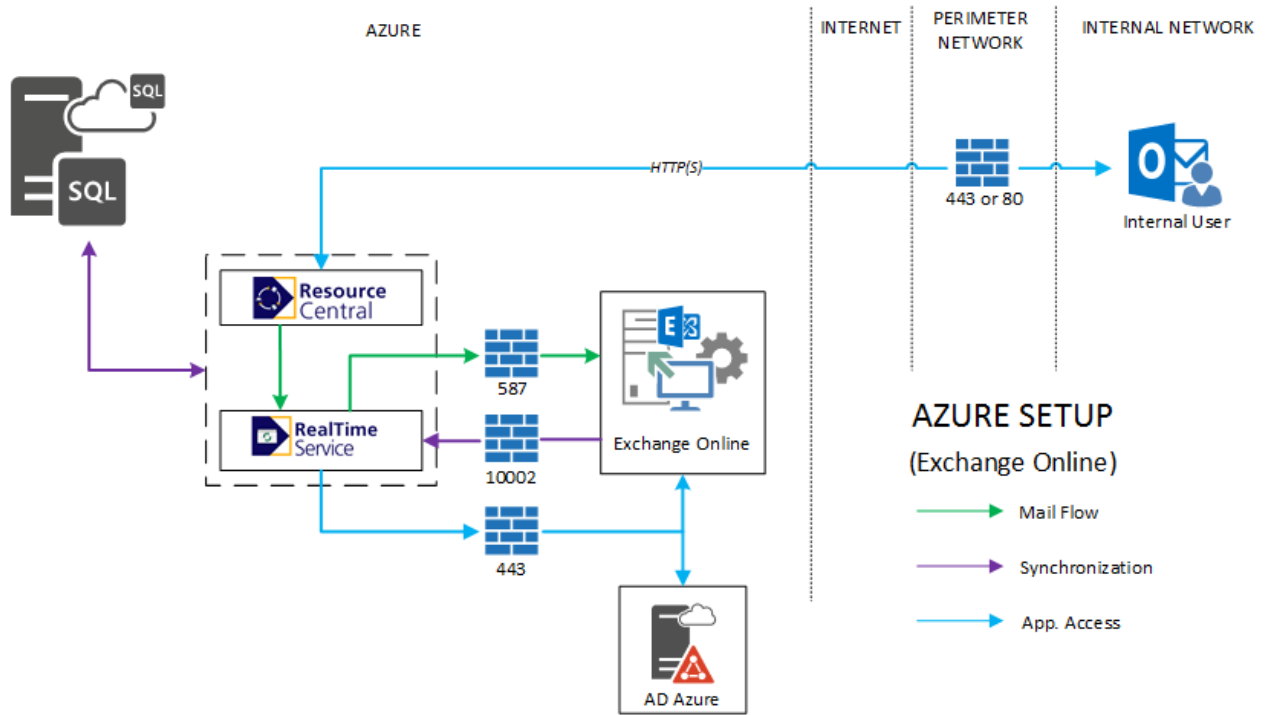


Figure 4. RC Diagram (Azure - Exchange Online)

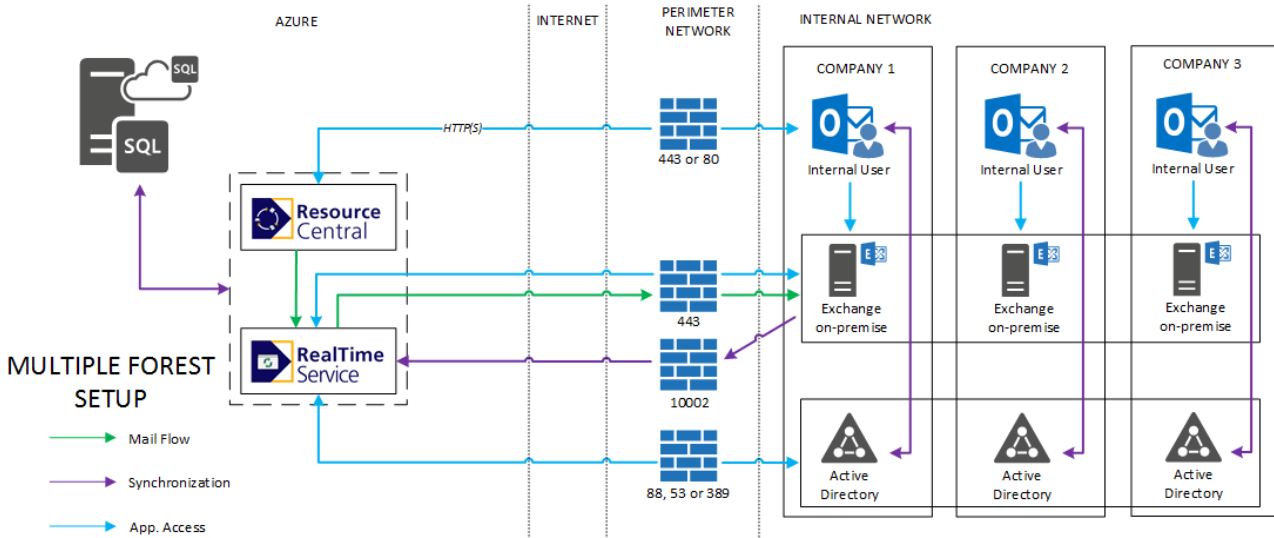


Figure 5. RC Diagram (Multiple Forest Setup)

## Resource Central components

### Resource Central Outlook Add-in

RC Outlook Add-in is the only client side component of the Resource Central system. It is installed on a client that has MS Outlook installed. This component is installed in the form of an Outlook Add-in, available in the toolbar of the Outlook. With the help of the two different interfaces of this component, the user can manage his/her personal appointments/meetings over the Physical Exchange resources via the RC system.



## Resource Central Web Application

Resource Central Web Application is also a server side component which is installed on an IIS server. With the installation of this package over the Web server, we have a complete Web application, whose different interfaces have been designed as per the privileges and roles of the people involved. Administrative users can make use of the complete and unrestricted access to the RC system and can manipulate each and every entity in the system. However, some administrators could be given a restricted access right.

## RealTime Service (RTS)

The RealTime Service collects data from the Exchange Server and stores it in specified destinations. In fact, synchronization happens when the service receives notifications from the Exchange Server in the real time or whenever it is requested. The RealTime Service can perform full synchronization: all data is replicated from the Exchange server and from Active Directory.

## Synchronize Service

Synchronize Service is a part of Resource Central Components which is responsible to communicate with Resource Central Database in tracking and synchronizing data changes of RC Database. Synchronize Service includes the following components:

- **SQL Service Broker:** Service Broker helps build asynchronous, loosely coupled applications in which independent components work together to accomplish a task. These application components exchange messages containing the information required to complete the task. The data was sent to Service Broker from RC database as conversation and stored in SQL Server Queue internally.
- **RC Processor:** This is a window service which listens to event changes from SQL Server Queue and builds email content based on RC Business following the process:
  - RC processor listens to the data changed in the SQL Server Queue and receives these contents through XML format, then parses to Reservation object of RC.
  - RC Processor listens to event and receives the change information, then builds the email content according to the RC Business and add these emails to EmailQueues table.
  - Read the EmailQueues table and send emails to RTS, then receives responses from RTS and update the Mails table.

## Maintenance Service

Maintenance Service is a part of Resource Central Components which is responsible for deleting unnecessary data, synchronizing data and sending reminder email.

Maintenance Service consists of the following jobs:

- **Auto Arrange Orders**
- **Clean Up Database**
- **Delete Log Files**
- **Delete Prior Booking**
- **Error Handling**
- **Reminder Email**
- **Remove Temp Data**
- **Synchronize Tasks**
- **Check Out Visitors**
- **Delete Visitor History**

Please refer to *Maintenance Service Guide* for more information.



## CHAPTER 2.

# Installation

---

In this chapter short check lists are presented for installation and connections among components of Resource Central system.

**NOTE:** Click **Ctrl + the hyperlink** in the checklists for detailed instruction to perform the setup. You might be able to navigate back to where you click the hyperlink by using the **Alt + left arrow** keyboard shortcut.

## Prepare for installation

To prepare for installation of RC, please have a look at the following knowledge base articles:

- [Exchange On-premises Resource Central requirements](#)
- [O365 Resource Central requirements](#)

## Install Web Application

1. Go to [System Requirements](#) page in Add-On Products website to have an overview of System requirements for Resource Central. Also, pay attention to [rights needed for RC web application installation](#).
2. Follow [step-by-step instruction](#) to install RC web application.

## Configure Web Application

After RC web application is installed, you have to make some configurations and setup based on the following list:

1. [Create RC database](#)
2. [Save the configuration settings](#)
3. [Specify URL to web application](#)
4. [Configure Basic parameter and setup SMTP account](#)
5. [Upload license](#)

## Install and configure Add-in

Refer to **RC COM Add-in 4.0 - Installation Guide** for more details.

CHAPTER 3.

# Appendices

## Appendix A: Rights for installation of RC web application/Add-in

<p><b>RC Web application</b></p>	<p>The user account, under which the Installation of RC Web Application is to be carried out, should have <b>Local Administrative Right</b>.</p> <p>Administrative account (e.g. 'rcadmin') needs to have Read/Write Access to the folders where the Resource Central web application is installed.</p>
<p><b>RC Add-in</b></p>	<p><b>For Everyone:</b> The user account, under which the Installation of RC Outlook Add-in is to be carried out, should have <b>Local Administrative Right</b>.</p> <p><b>Only me:</b> No specific right is needed.</p>

## Appendix B: Step-by-step installation of RC Web Application

Copy RC IIS setup folder from the package to the local drive of Web Server machine. Open installation package and run RC setup file (e.g.: ResourceCentral 3.8.0001.0028.exe) from this folder. This will start the following sequence of startup screens; follow the instructions on the screens to complete the installation successfully.

**Step 1-** Double click RC setup file. Welcome dialog of set up wizard will show up as shown below:

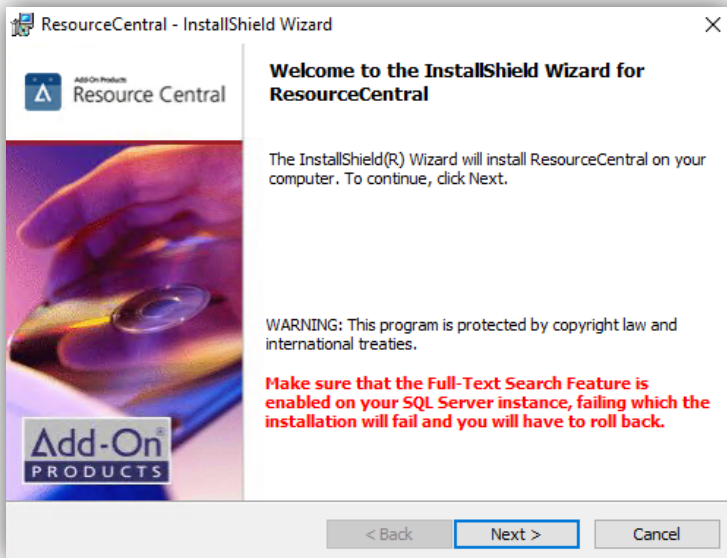
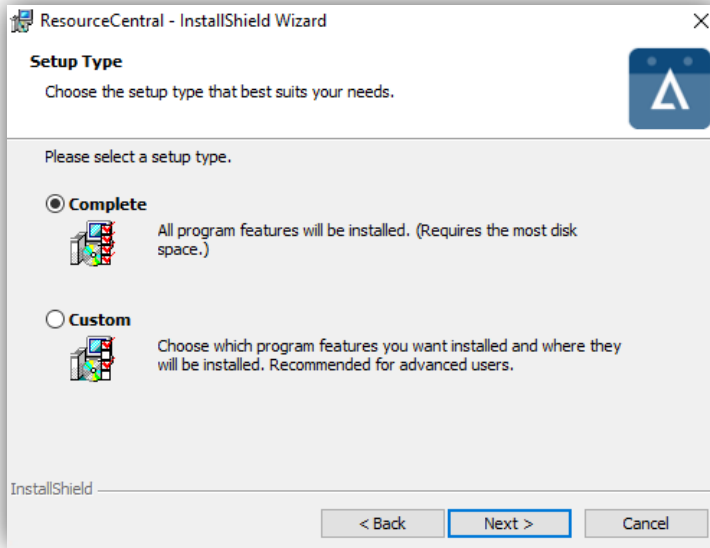


Figure 6. Welcome screen

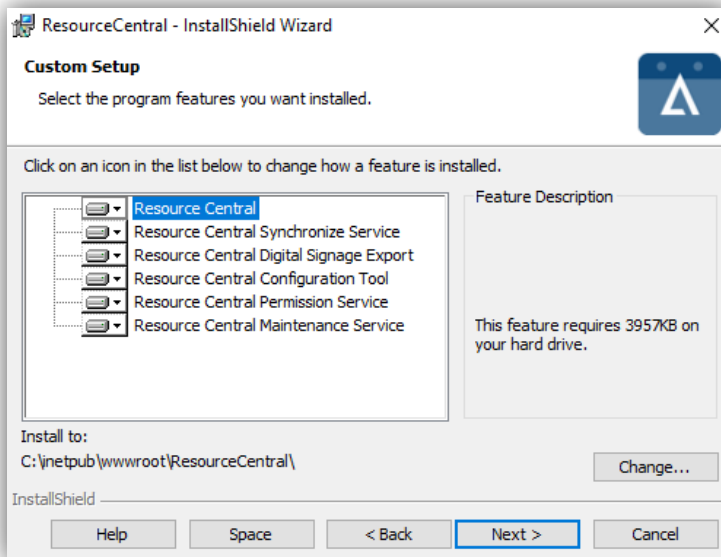


**Step 2-** Click **[Next]**. The Setup Type screen would appear, as shown below:



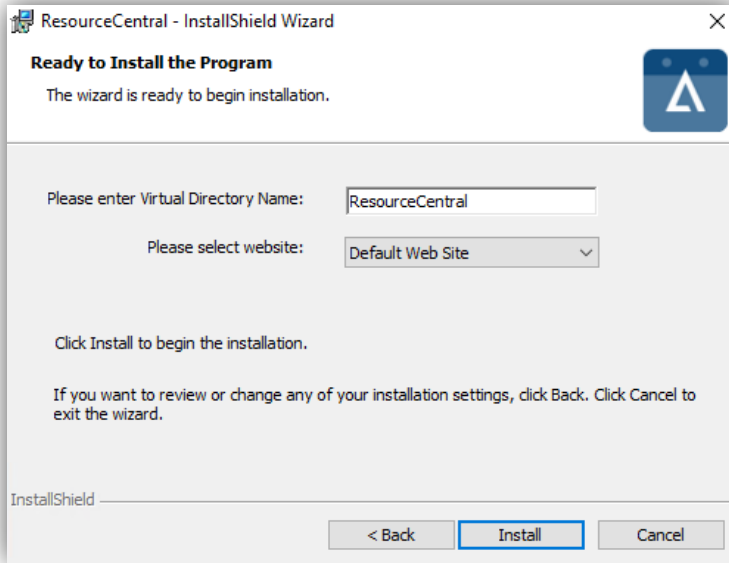
**Figure 7. Setup type**

If you check “**Custom**” type and click **[Next]**, you can select components to be installed in “**Custom Setup**” screen:



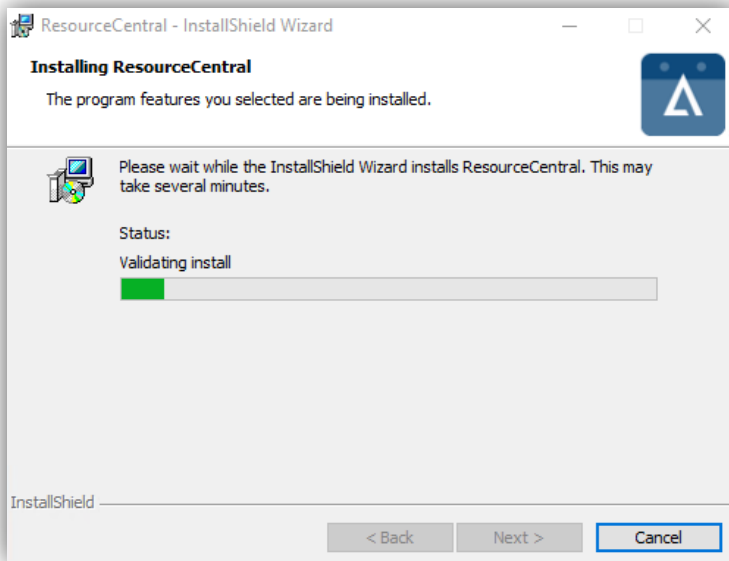
**Figure 8. Custom setup**

**Step 3-**



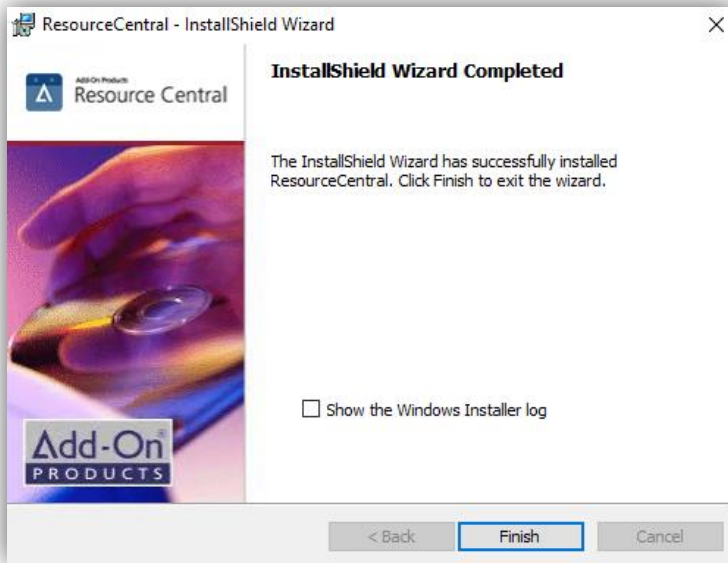
**Figure 9. Ready to Install**

**Step 4-**



**Figure 10. Installing Resource Central**

**Step 5-**



**Figure 11. Installation Complete**

By default, RC web application is installed in the following folder: ***C:\inetpub\wwwroot\ResourceCentral.***

## Appendix C: Web Application configuration

### Create RC database

Start the configuration utility from **C:\Program Files (x86)\Add-On Products\RC Configuration Tool**. This will show the following window:

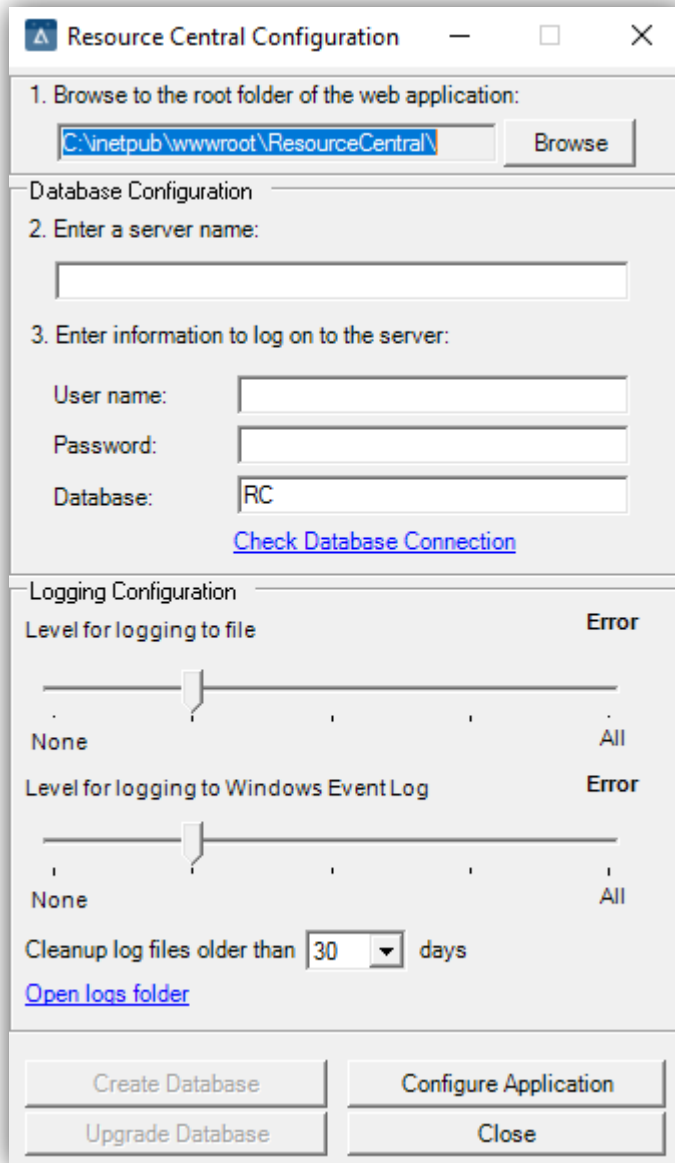


Figure 12. RC Configuration Tool

Specify the complete path to the **RC Application's root folder** (Virtual Directory). Application will select this folder automatically. However, you can change it afterwards.

Now in the **Database Configuration section**, you can communicate with the Database Server by specifying the Server Name (e.g. 'gl-db1') (for the named instance it should be like GL-DB1\InstanceName) and the Name of the Database with which you want the New Database to be created and user name, password.

Database Configuration	
Enter a server name	Enter Database Server name

User name and Password	User name and password of the SQL server account to log on to the SQL server
Database	Name of database that RC uses
<b>Logging Configuration</b>	
Level for file logging	Select level of logging (Off, Error, Warning, Information, Debug)
Level for logging to Windows Event Log	Select level for logging in Event Log of Windows (Off, Error, Warning, Information, Debug)
Cleanup log files older than	Select a certain number of days to keep the log files. Default value is 30 (days)

**NOTE:**

- Account for creating RC database (details in **Enter information to log on to the server** section) must have **Owner** role.
- You need to install Full-text Search on SQL server to be able to create/upgrade database. Without this feature, the **[Create Database]** and **[Upgrade Database]** buttons will be disabled.

Click the **[Create Database]** button. This will check if the Database with the same name as that you are about to create, exists at the specified DB Server. If the DB with the same name exists at the specified DB Server, then the following warning message will be displayed:

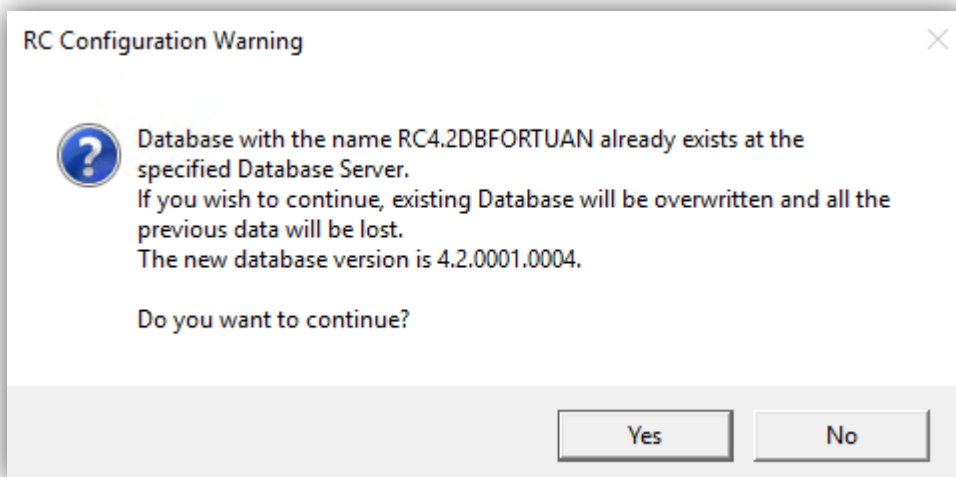


Figure 13. Database Warning Message

**NOTE:** If you select YES, then the DB will be overwritten and all the previous data will be lost.

If the DB with the same name does not exist at the DB Server, then a console window will open and ask for your confirmation:

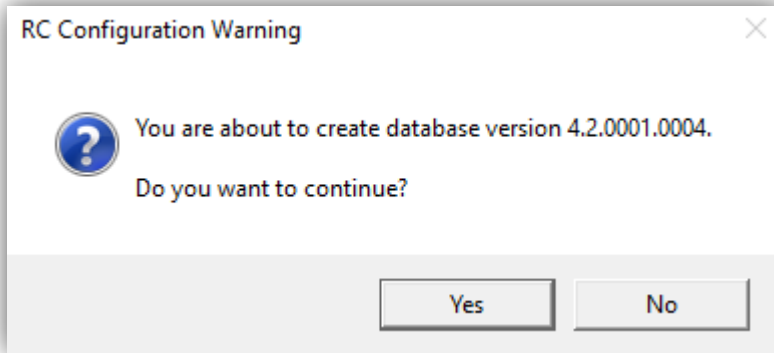


Figure 14. Database Creation

Click [Yes] to proceed, the creation process starts:

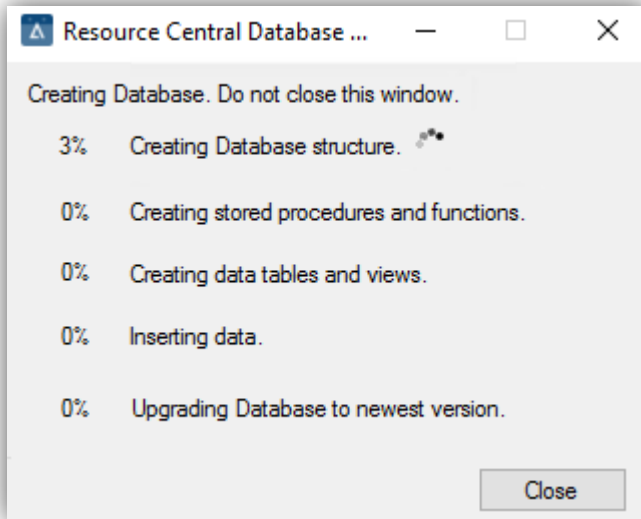


Figure 15. Database creation process

After the successful installation of the database, this window will close automatically and the **Successful Installation message** will be shown.

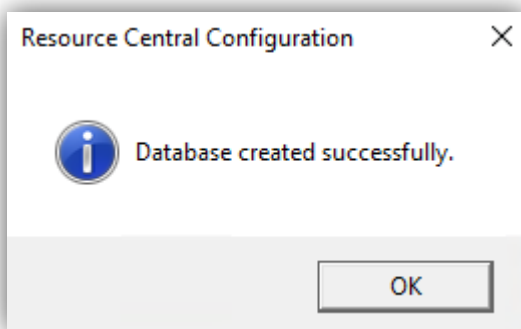


Figure 16. Database Created Message

If some of the Database Configuration information is not correct, then an error message stating the reason would be shown to the user.

**NOTE:** This utility assumes that the SQL Server has been installed and running in SQL Server Authentication mode, mixed mode.

### Save the configuration settings

In this section, we will discuss how to save the RC Application Configurations so that the Web application could make use of it.

Start the RC Configuration Utility from **Start → Programs → Add-on Products → Resource Central → RC Configuration**.

Refer to the previous section ([Create RC Database](#)) to know how to enter necessary information in RC Configuration Utility.

Now click the **[Configure Application]** button which will save the configurations in all the required files, and will show you confirmation message as shown below:

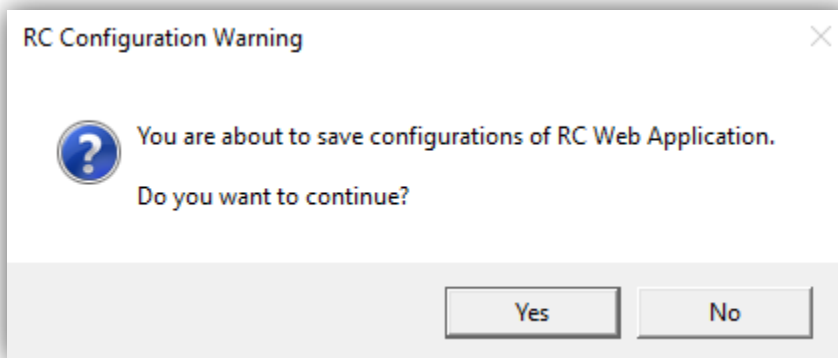


Figure 17. Application configuration confirmation Message

Click **[OK]**, the configuration process starts and when it is finished, the following dialog shows up:

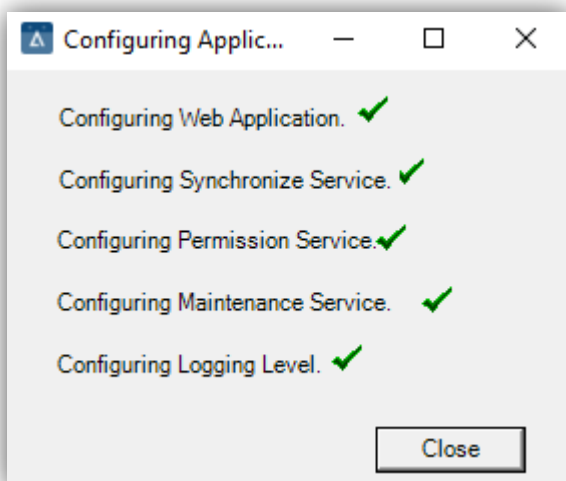


Figure 18. Configuration Saved

### Specify URL to web application

In order to run the Resource Central application, launch the Internet Explorer and specify the following URL in the address bar:

URL: [http\(s\)://<ServerName>/<VirtualDirectoryName>/admin/login.aspx](http(s)://<ServerName>/<VirtualDirectoryName>/admin/login.aspx)

In order to log in the application and use it for the first time, you can login with system/manager (user name/password respectively). And then, change the password as you wish.

### Configure Basic parameters

In order to make RC work properly, some basic parameters must be set up in Resource Central Manager. Refer to **Chapter 4, “Parameters – Basic”** section in *Resource Central Administrator Guide* for more details.

### Uploading license for Resource Central

Resource Central application uses Resources to be used for all the operations. The nature and limit of these resources depend upon the credentials of the License on which the RC application is running.

In order to upload a License, the user will have to perform the following steps:

1. Navigate to RC Manager → General → License and click the “**Upload**” button

Figure 19. License upload

2. User can upload License File (XML), Key file (Public) and fill in Activation Key through this screen.

Field	Description
License file (xml)	Click the browse button and select the name and path of the License xml file which you have received
License key file	Click the browse button and select the name and path of the License key file which you have received
Activation Key	A 16-digit unique alpha-numeric Product Activation key which would be used to activate the RC Web application

If the user has uploaded a new license by following the above mentioned procedure, then when the application is un-installed, that particular license is not un-installed automatically. In order to remove that license, you will have to manually delete the License folder at the installed path.

**NOTE:** It is strongly recommended to manually delete the previously uploaded License (License Folder) before trying to install the new application.

## Appendix D: Configure Single Sign-On using Windows Authentication

Refer to this [Knowledge Base](#) article for more details.



## Appendix E: RC Digital Signage Export settings

Resource Central Digital Signage Export is a **Windows Service**, which facilitates the integration of Resource Central with external systems. This service **extracts** the data of **future reservations** from RC database and saves it in the form of an **XML** file as configured by the organizer and uploads it to an **FTP Server**.

By default, this service is not selected to install:

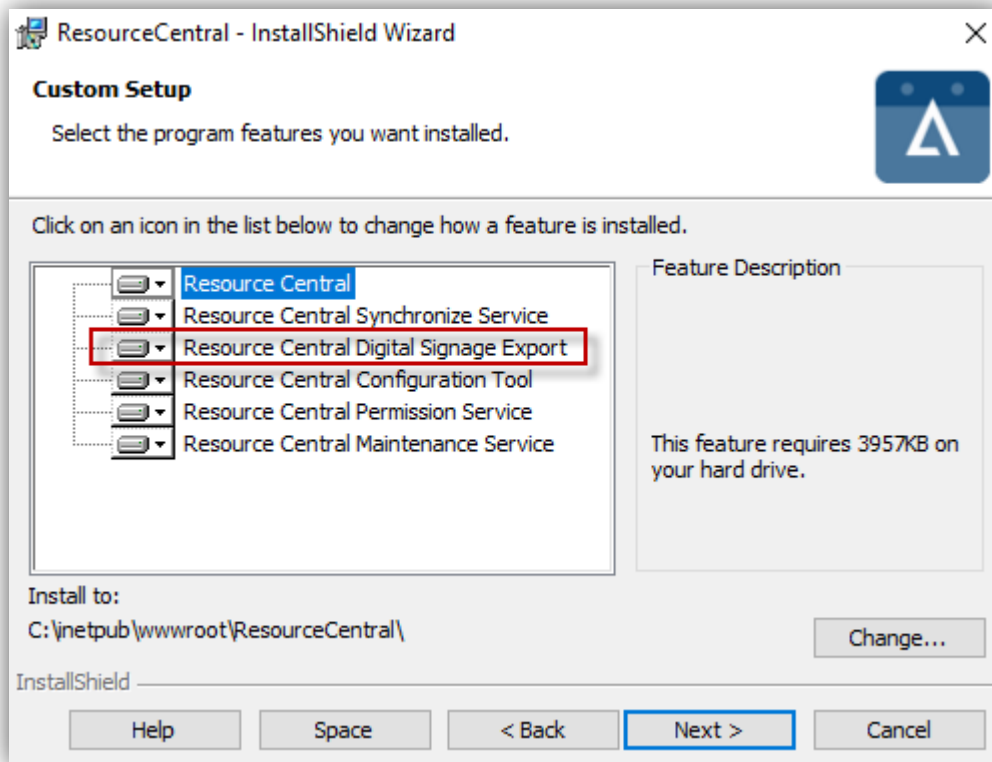


Figure 20. Install Web application – setup wizard

After you select Resource Central Digital Signage Export to be installed, it is still turned **OFF** by default. When you configure this service, via the RC Digital Signage Export Configuration utility, this service would start running.

**NOTE:** If the server has been restarted for any reason, you will have to explicitly turn this service ON.

After the Resource Central Web setup is completed, a shortcut named “**RC Digital Signage Export Configuration**” is placed at the desktop (It can also be accessed at **C:\Program Files (x86)\Add-On Products\RC Digital Signage Export**). This is .exe by the help of which you can configure the Digital Signage Export. The Digital Signage Export related files could be found in this folder.

### Digital Signage Export overview

When you run the “RC Digital Signage Export Configuration”, the following screen would be displayed:

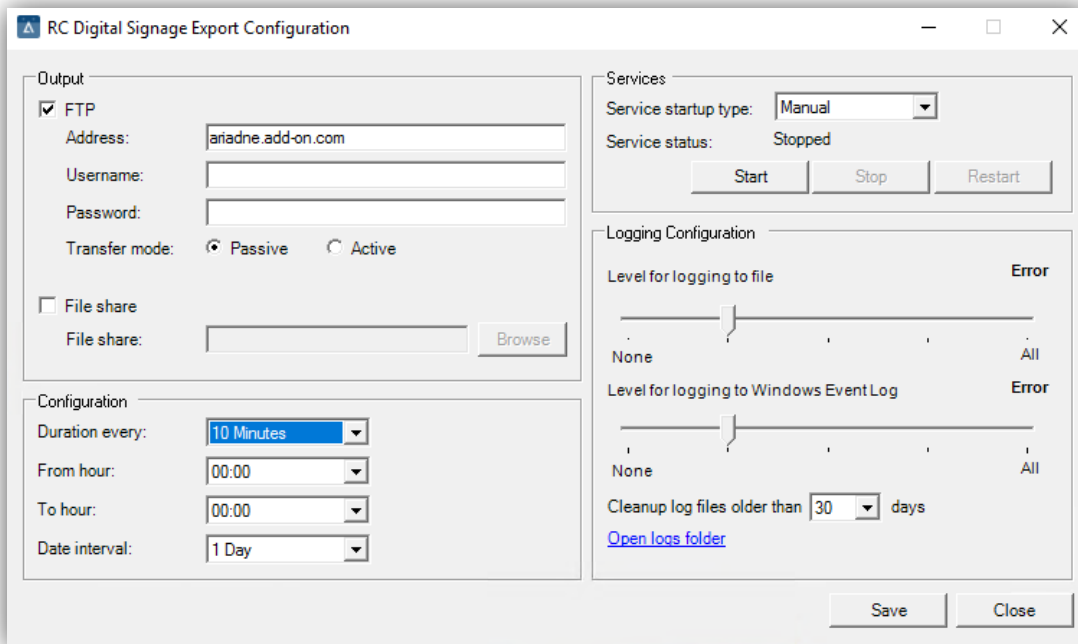


Figure 21. RC Digital Signage Export Configuration Utility

Fields	Description
<b>Address</b>	Address of the FTP Server <b>Wrong input example: 'ftp://server1'</b> <b>Correct input example: 'server1'</b>
<b>User name</b>	User name to log on to the above mentioned FTP site
<b>Password</b>	Password of the above mentioned user name
<b>Transfer mode</b>	Select transfer mode of FTP
<b>File share</b>	Path to folder where XML config file is saved
<b>Duration every</b>	Interval with which you want the XML to be generated and uploaded to the mentioned FTP. (Default=30 seconds)
<b>From Hour</b>	Start time from which you want the XML to be generated (after the Duration specified)
<b>To Hour</b>	End time by which you want the XML to be generated
<b>Date interval</b>	Time range in which the data will be retrieved.
<b>Service startup type</b>	Type of the service at startup
<b>Service status</b>	Status of the service
<b>Level for logging to file</b>	Select level of logging (Off, Error, Warning, Information, Debug)
<b>Level for logging to Windows Event Log</b>	Select level for logging in Event Log of Windows (Off, Error, Warning, Information, Debug)
<b>Cleanup log files older than</b>	Select a certain number of days to keep the log files.

After providing values in all of the above-mentioned fields, when user clicks **[Configure Application]**, these values are saved and the user is informed by a confirmation message. Also, the Windows Service is started at the backend.

### Parameters to be created in the RC system

In order to enable the Resource Central application to coordinate/communicate with the Digital Signage Export, following parameters should be created in the RC application. These parameters will be created at **RC Manager → General → Parameters** section.

Parameters	Descriptions
<b>DigitalSignExportCustomerID</b>	Its value is used as customer ID in the fetched records in the output XML. Its value is also used as target XML File Name.
<b>DigitalSignExportEventDescription</b>	You will have to create a property with the same name as given in this parameter's value. This property would be associated with the resource in order to populate it in the <b>Event Name</b> field in output XML file.
<b>DigitalSignExportCompanyName</b>	You will have to create a property with the same name as given in this parameter's value. This property would be associated with the resource in order to populate it in the <b>Company Name</b> field in output XML file.
<b>DigitalSignExportGroupEvent</b>	You will have to create a property with the same name as given in this parameter's value. This property would be associated with the resource in order to populate it in the <b>Groupevent</b> field in output XML file.
<b>DigitalSignExportUseMeetingDoorSign</b>	You will have to create a property with the same name as given in this parameter's value. This property would be associated with the resource as a checkbox, with the value <b>'YES'</b> . If the organizer checks this property while placing an order against a reservation, that reservation would be included in output XML file.

Once all the above mentioned parameters are set up properly and you have successfully configured the Digital Signage Export, then the Windows Service will generate and upload the XML file to the configured FTP at the defined Intervals.

### Verification Points for Digital Signage Export

Following are the verification points for the Digital Signage Export. Also note that these are the minimum settings that should have been done to extract the data in the output XML:

- A. Digital Signage Export has been successfully configured
- B. **'DigitalSignExportCustomerID'** and **'DigitalSignExportUseMeetingDoorSign'** parameters have been created and configured
- C. Some reservations do exist on Normal Resource(s) in the future.
- D. Order has been placed against those reservations, along with the 'Digital Sign Export Use Meeting Door Sign' property checked.

### Configuring Digital Signage Export with UNC path

In case you need Digital Signage Export with UNC path, follow the steps below:

**Step 1:** Go to [Microsoft Azure](#) → **Subscription** → Open a Subscription → Go to **Resources**.

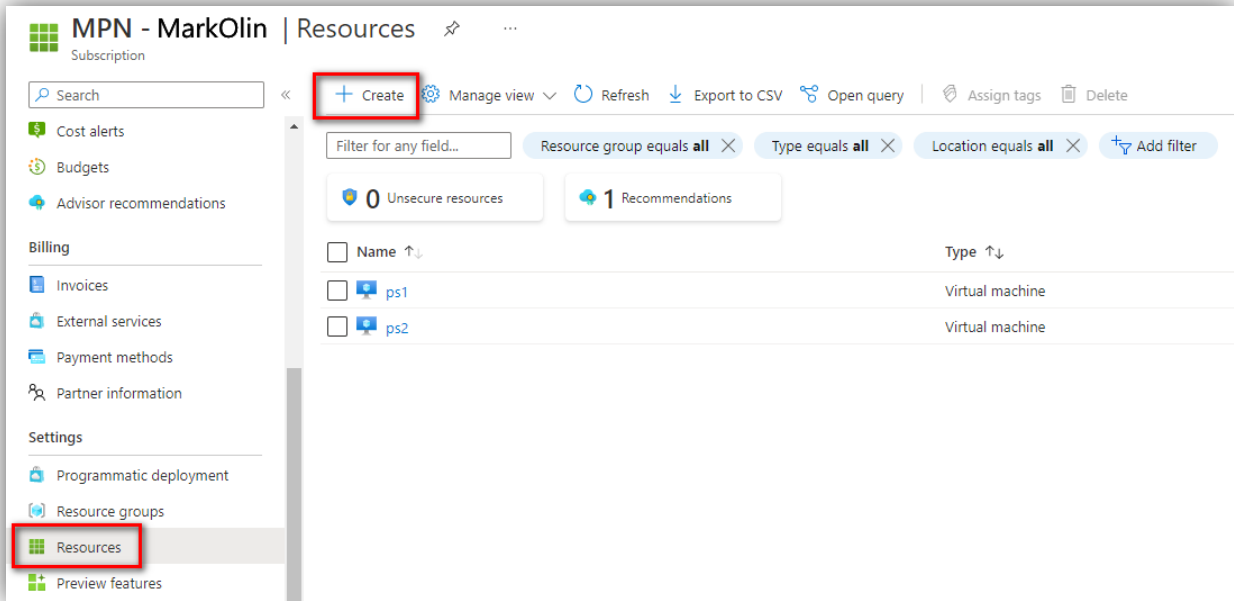


Figure 22. Open a Subscription → Resources → click [Create].

Then click [Create].

Step 2: On 'Create a resource' page, find **Storage account** and click [Create].

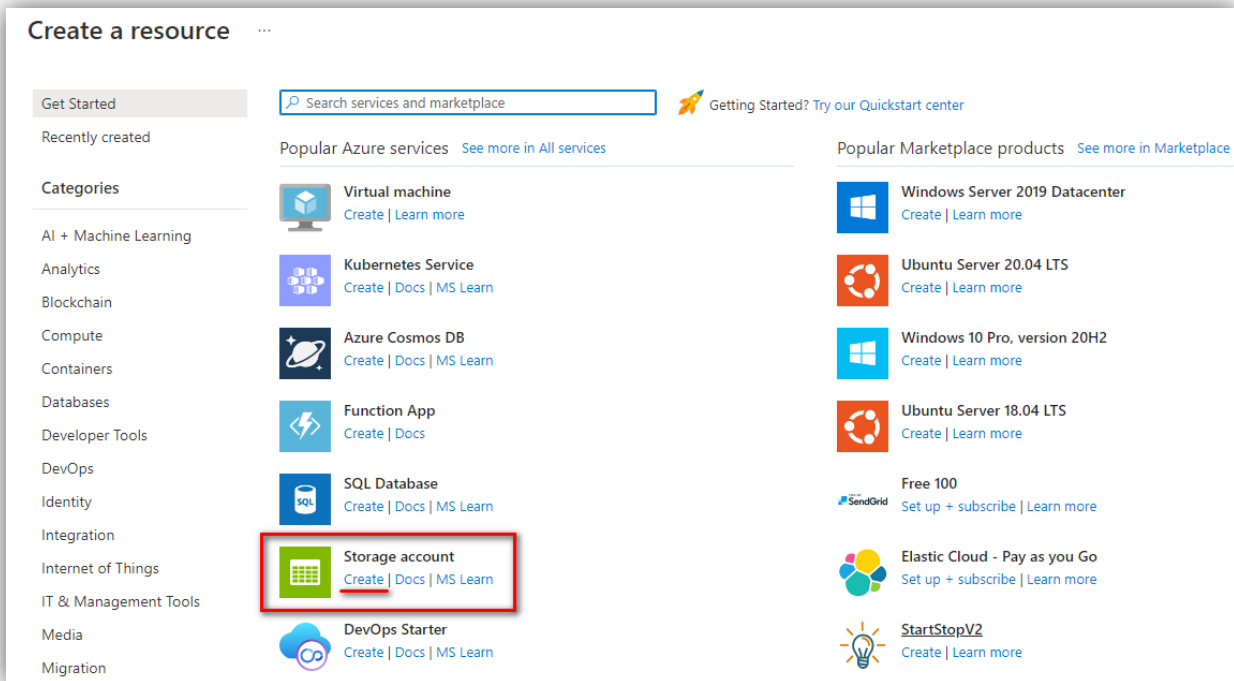


Figure 23. Find and create Storage account.

Step 3: On 'Create a storage account' page → **Basics** screen, fill in the required fields.

- On 'Project details' section, select the Subscription that you opened in Step 1, and select a Resource group to manage this account:

**Create a storage account** ...

Basics | **Advanced** | Networking | Data protection | Encryption | Tags | Review

Azure Storage is a Microsoft-managed service providing cloud storage that is highly available, secure, durable, scalable, and redundant. Azure Storage includes Azure Blobs (objects), Azure Data Lake Storage Gen2, Azure Files, Azure Queues, and Azure Tables. The cost of your storage account depends on the usage and the options you choose below. [Learn more about Azure storage accounts](#)

**Project details**

Select the subscription in which to create the new storage account. Choose a new or existing resource group to organize and manage your storage account together with other resources.

Subscription \*

Resource group \*  [Create new](#)

Figure 24. Create a storage account – Basics – Project details.

- On 'Instance details' section, enter a Storage account name and select Region, Performance, Redundancy based on your needs. Once you are done, click **[Next]** button to go to the next screen.

**Instance details**

If you need to create a legacy storage account type, please click [here](#).

Storage account name ⓘ \*

Region ⓘ \*

Performance ⓘ \*  **Standard:** Recommended for most scenarios (general-purpose v2 account)  
 **Premium:** Recommended for scenarios that require low latency.

Redundancy ⓘ \*   Make read access to data available in the event of regional unavailability.

Figure 25. Create a storage account – Basics – Instance details.

- On other screens, you can make your configurations until you reach the **Review** screen to check all your settings.

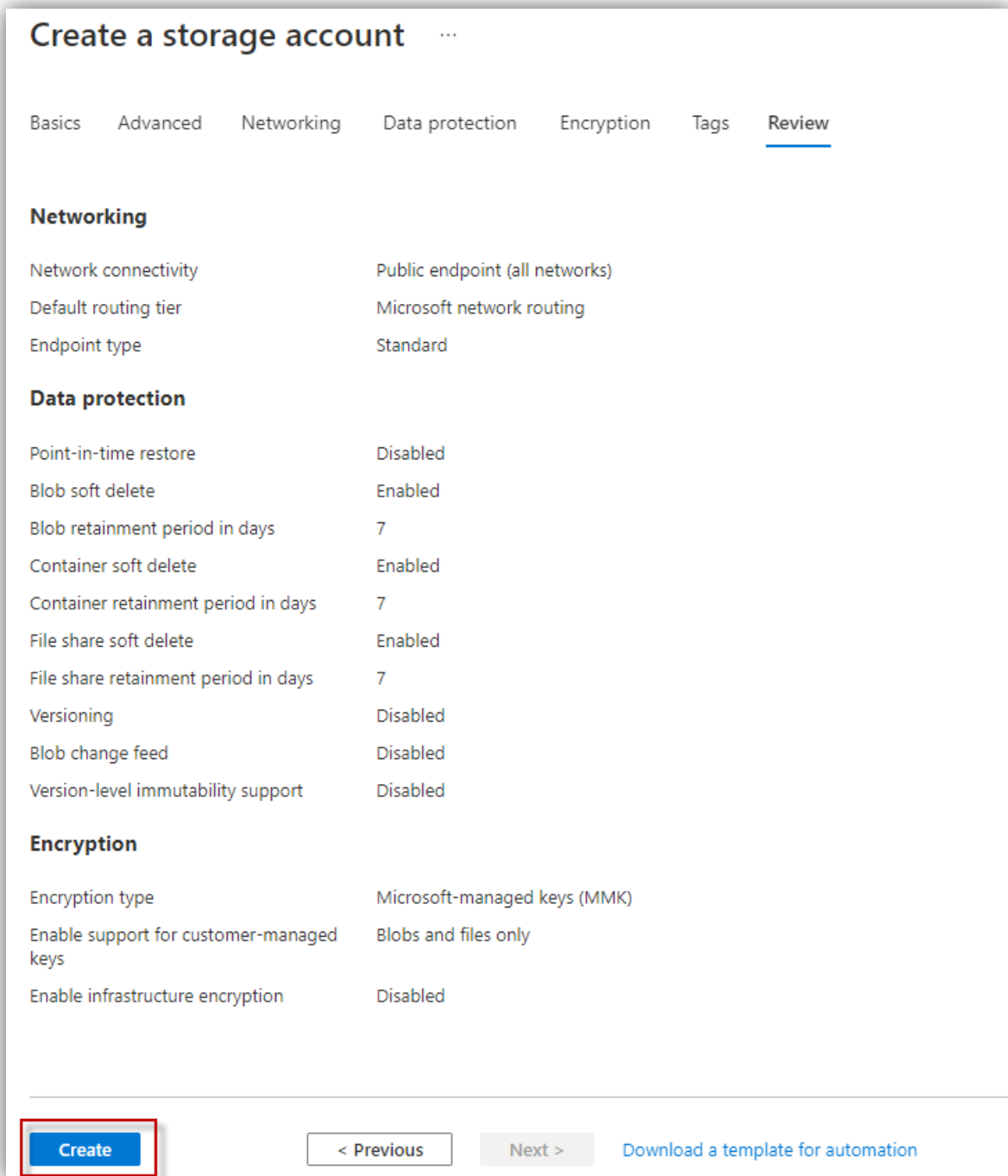
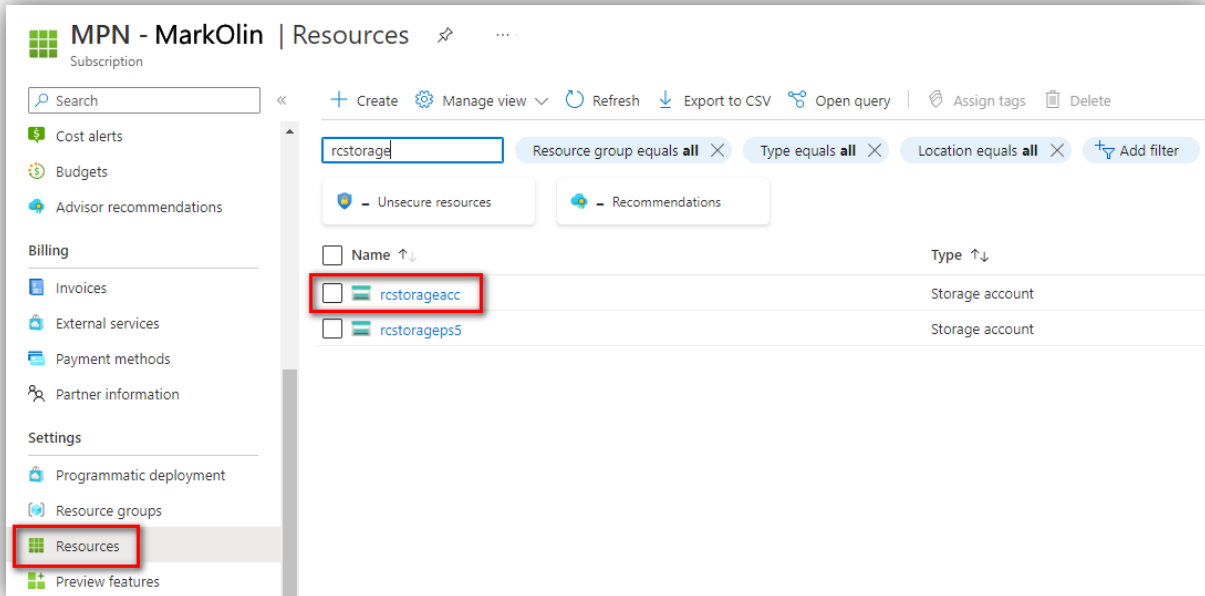


Figure 26. Create a storage account – Review.

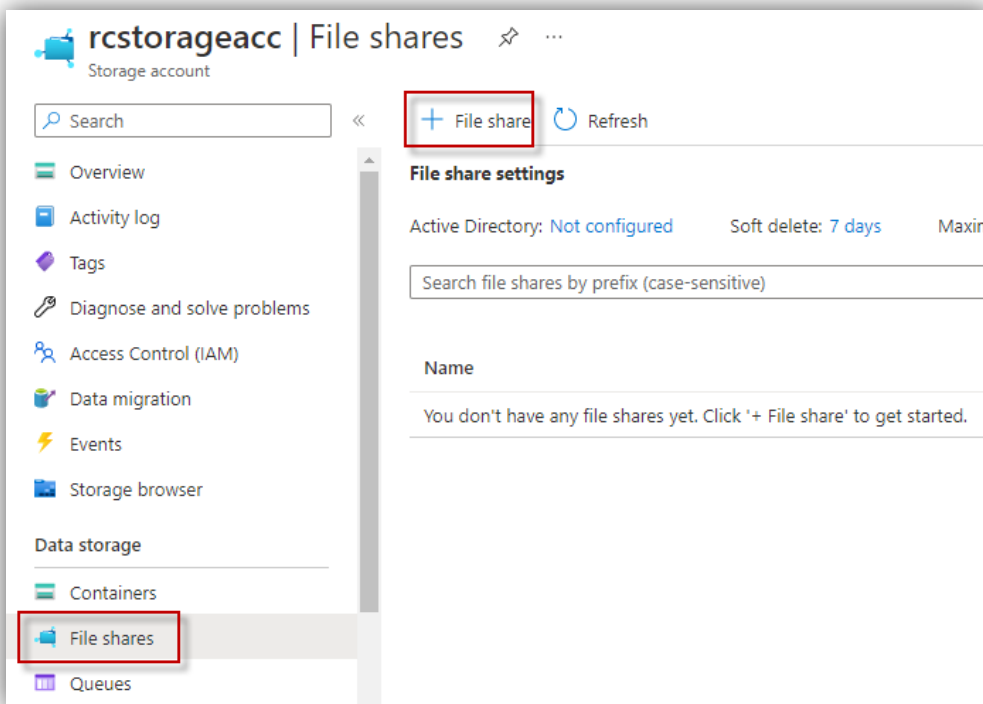
If you do not want to make any other changes, click [**Create**].

**Step 4:** Go to your subscription again → **Resources**, and search for your created storage account.



**Figure 27.** Open the Subscription → Resources → go to the created storage account.

Next, click on the created storage account and go to its **File shares** page. Then click **[+ File share]**.



**Figure 28.** Create File share in the created storage account.

After clicking the button, the 'New file share' screen is opened on the right side in which you can enter a name and select a performance tier.

**New file share** [Close]

Name \*  
filetransfer

Tier ⓘ  
Transaction optimized

Performance

Maximum IO/s ⓘ	1000
Egress Rate ⓘ	60 MiB / s
Ingress Rate ⓘ	60 MiB / s
Maximum capacity	5 TiB
Large file shares	Disabled

Figure 29. Creating New file share.

When you are done, click **[Create]**. You will see the created file share on the list.

rcstorageacc | File shares [Share] [More]

Storage account

Search [ ] << + File share Refresh

**File share settings**

Active Directory: Not configured    Soft delete: 7 days    Maximum capacity: 5 TiB

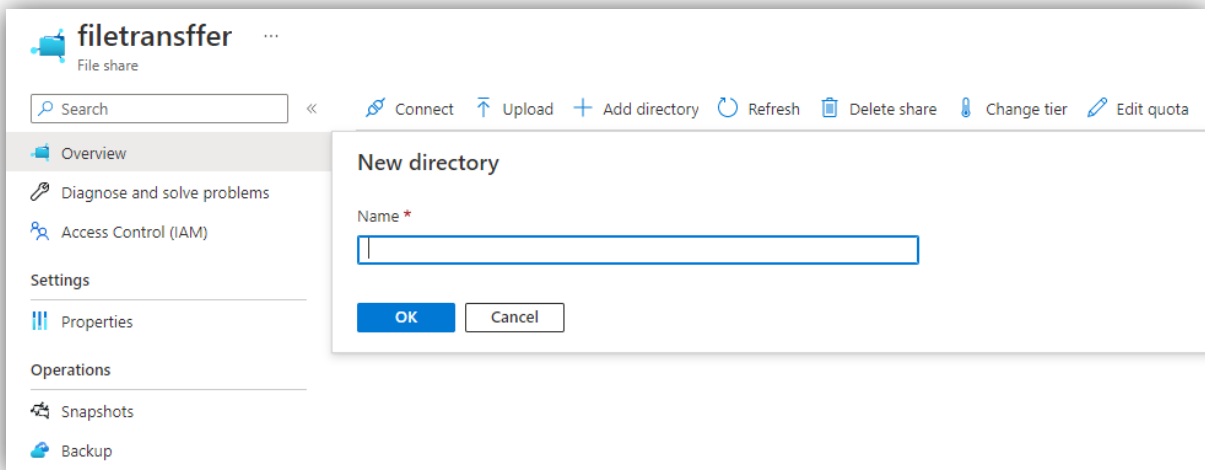
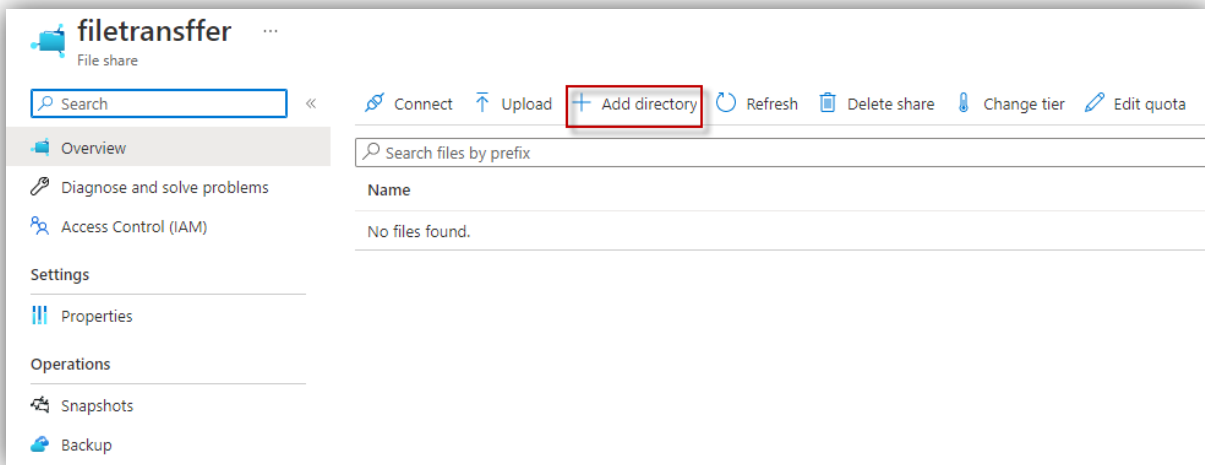
Search file shares by prefix (case-sensitive)

Name

- filetransfer

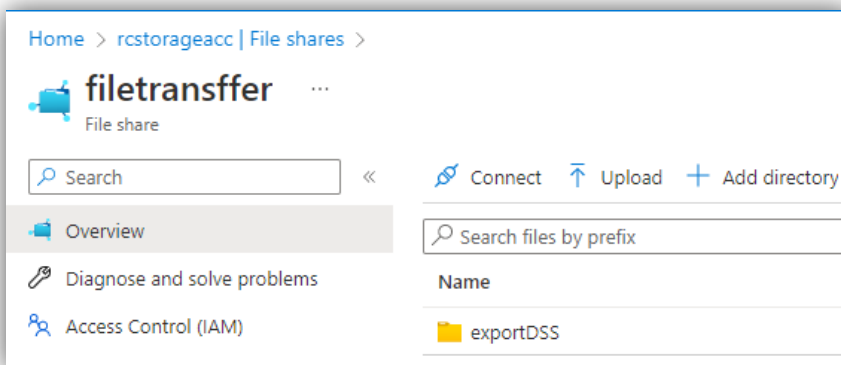


**Step 5:** Open the created file share. Then click **[Add directory]** which will open a field for you to enter the directory name. Then click **[OK]**.

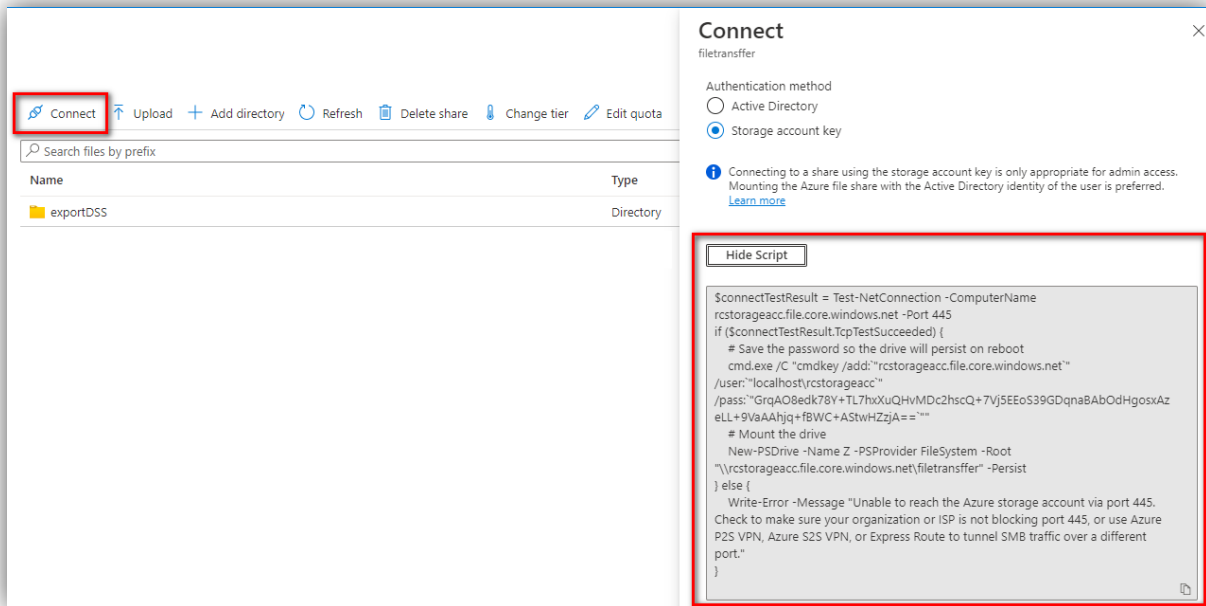


**Figure 30. Creating New directory.**

After that, you will see new directory created in the list.



**Step 6:** Still on the created file share page, click [**Connect**] which will open the screen on the right side.

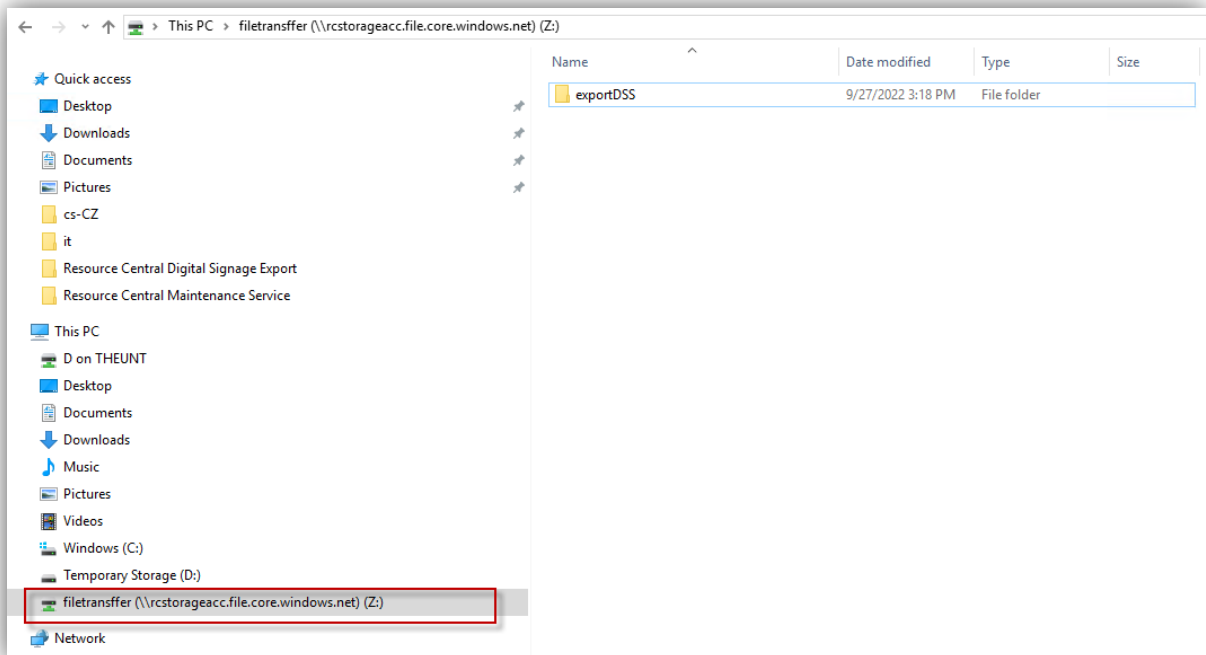


**Figure 31.** File share connect.

On this 'Connect' screen, click [**Show Script**] and copy the revealed script.

**Step 7:** On the machine that installed RC Digital Signage Export tool, run the script that you copied above with Windows PowerShell.

Once it is done, you will see the created file share on the machine, along with its directory.



**Figure 32.** File share on the machine that installed RC Digital Signage Export tool.

**Step 8:** On the machine that installed RC Digital Signage Export tool, open **Services** and find 'Resource Central Digital Signage Export'.

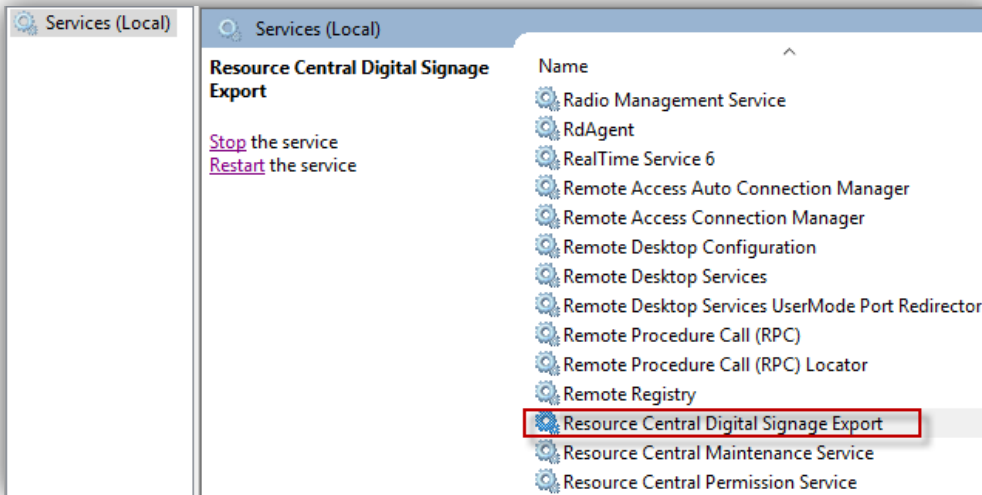


Figure 33. Find Resource Central Digital Signage Export service.

Right-click on it and click **Properties** → **Log On**.

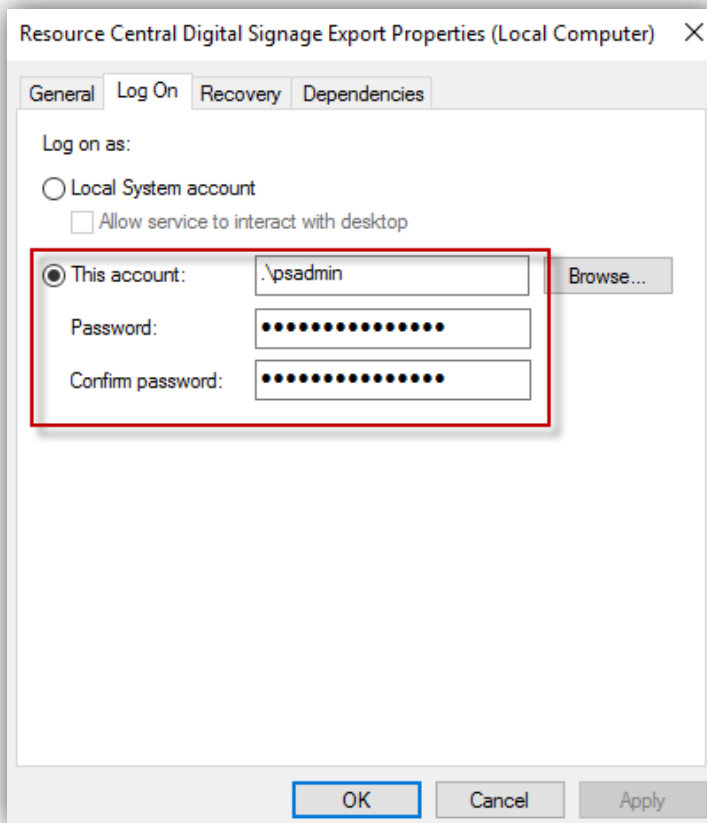
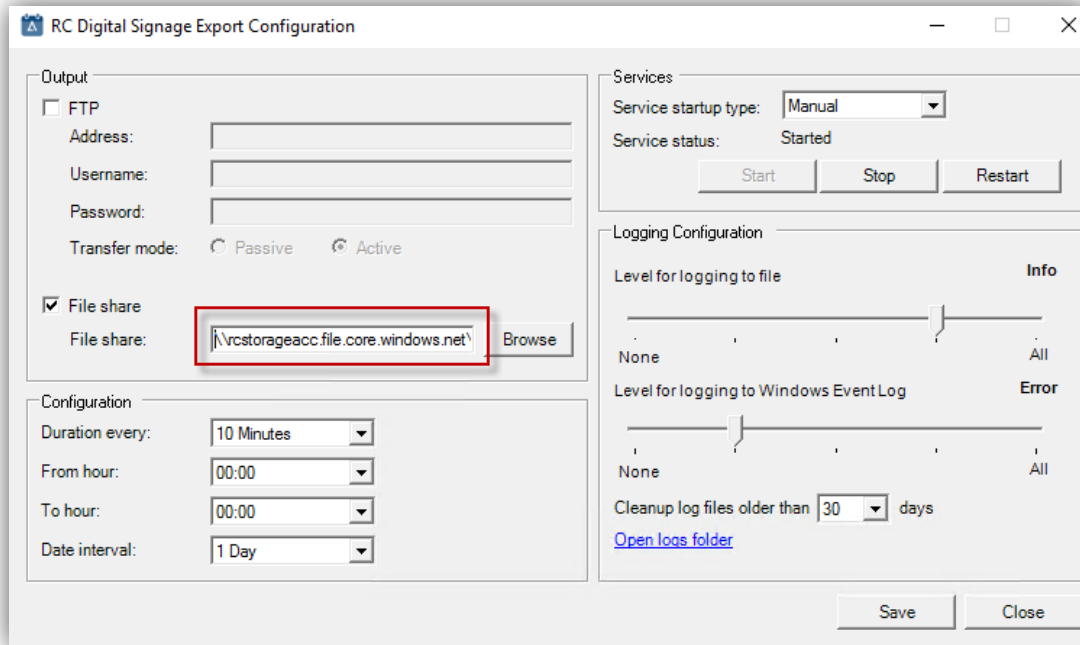


Figure 34. Resource Central Digital Signage Export Properties → Log On.

Here, select 'This account' and enter user name & password of any account existing on this machine. Then click [OK].

**Step 9:** Open 'RC Digital Signage Export Configuration' on the machine, then check on the 'File share' option.

Next, copy the directory path that you want to store the XML file (which you can access from your machine after Step 7) to the field 'File share' on the tool.



**Figure 35.** Copy & paste the directory path to 'File share' field.

In this example, the path is: \\rcstorageacc.file.core.windows.net\filetransfer\exportDSS

## Appendix F: Twain configuration

In Order to run the twain application for scanning and capturing of documents and pictures, you need to perform the following steps:

**Step 1:** Locate the Twain Folder which would have been created at the Default Installation Path. i.e. "C:\Program Files (x86)\Add-On Products\Twain" (the Twain Driver is installed on the server after the installation of RC Backend).

**Step 2:** Verify that the "RCTwain.exe" exists in this folder.

**Step 3:** Create a folder **Twain** on the system where your scanner or camera is attached to i.e. C:\Twain.

**Step 4:** If the folder you created is not C:\Twain, you must configure this path in **Visitors.TwainApplicationPath** parameter (Value of this parameter is the path to the folder you have just created). See **Parameter Guide** for more details.

**Step 5:** Copy "RCTwain.exe" file to the folder created in **Step 3**

**Step 6:** Open Internet Explorer and navigate to **Tools → Internet Options**, as shown below:

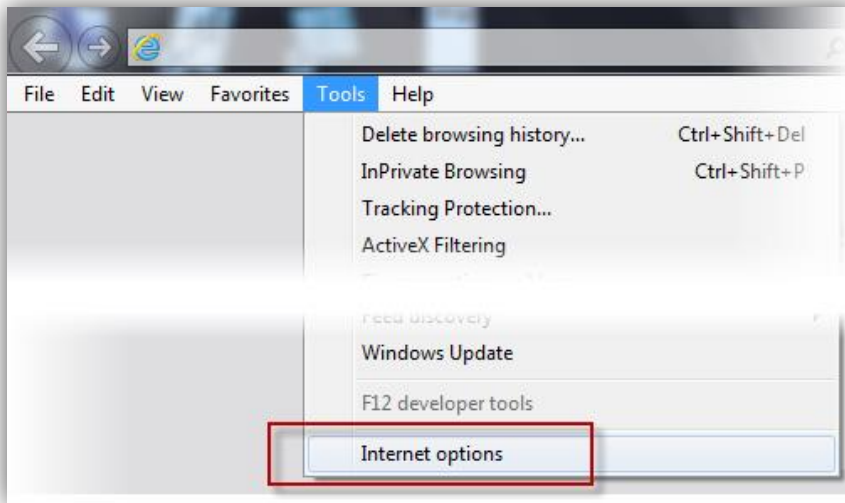


Figure 36. Internet Explorer – Internet Options

**Step 7:** On Security Tab of “Internet Options” dialogue click [Custom Level] button, as shown below:

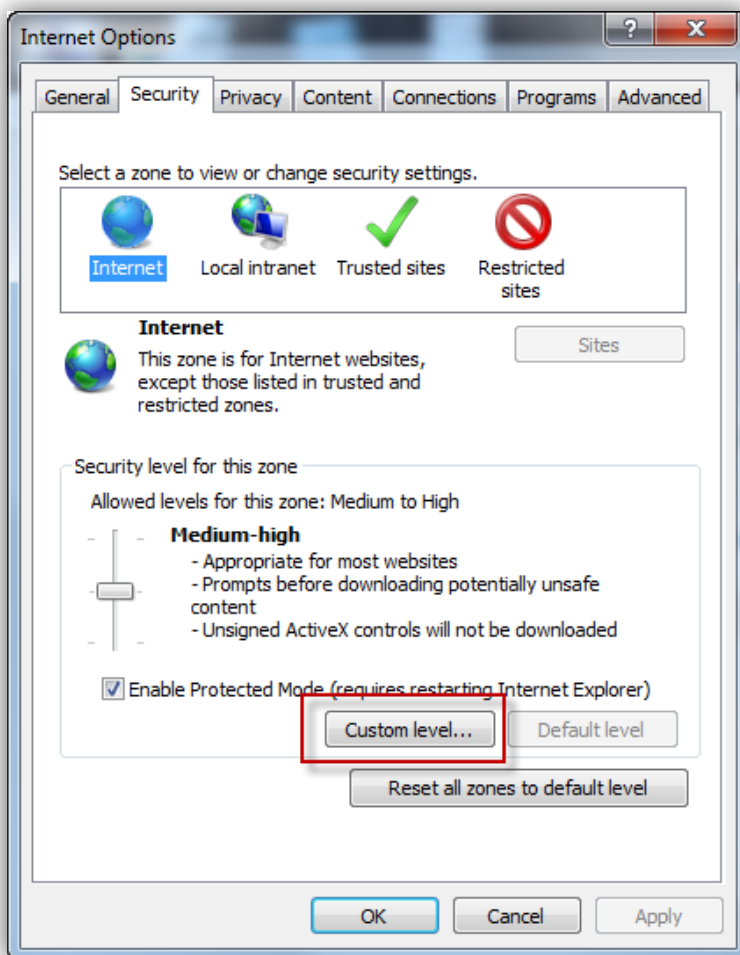


Figure 37. Internet Options – Security Tab

**Step 8:** When “Security Settings” dialogue opens, navigate to “Initialize and script ActiveX controls not marked as safe” and set its value as “Enable”. Click OK button, as shown below:

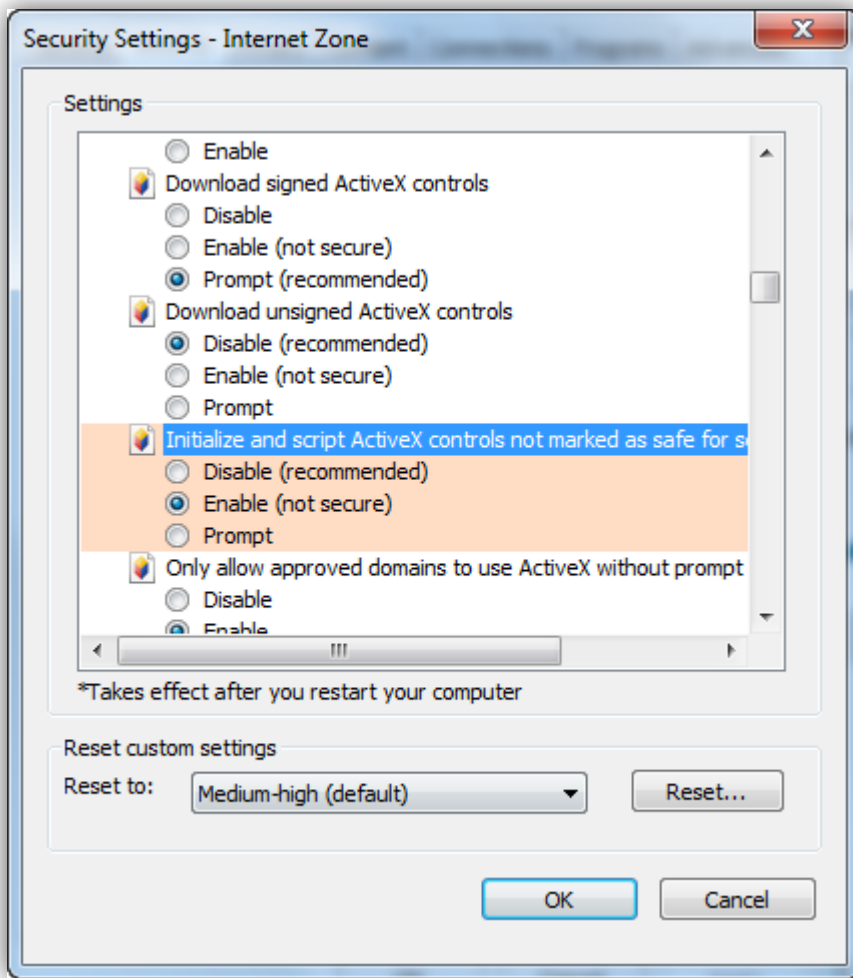


Figure 38. Custom Level – Security Settings

**Step 9:** A confirmation message of change of security settings will appear. Click [Yes] to save to changes made in security settings, as shown below:

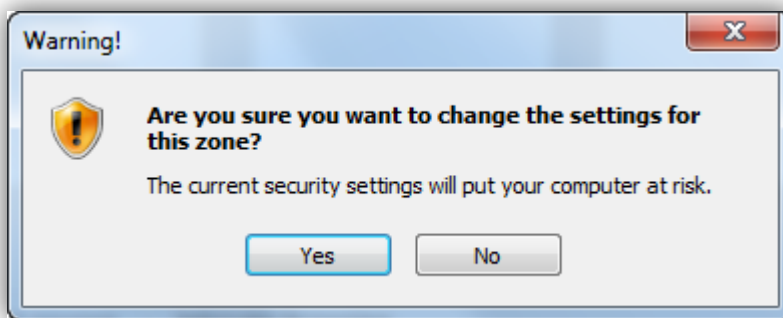


Figure 39. Security Settings Confirmation Dialog

**Step 10:** Click [OK] button on “Internet Options” dialogue.



## Appendix G: Uninstallation

### Removing RC Web Application

To un-install the RC Web Application, go to **Start Menu → Settings → Control Panel → Add/Remove Programs**. Select the RC Web Application listed and then click **'Remove'**. The RC Web Application would be completely un-installed from the system.

Please note that if the RC Web Application was running on a Demo license that comes with the application, then that license will be un-installed with the application.

But if you have uploaded a Custom License for the RC Web Application, then that License would not un-install with the un-installation of the RC Web Application. Rather, the License folder would remain at the install path of the RC Web Application and you will have to manually Remove/Delete that License Folder.

**REMARK:** It is strongly recommended that you manually delete that License folder before installing the new application.

After removing RC Web Application, you should manually delete the **Resource Central** folder located at: **C:\inetpub\wwwroot**.

### Removing RC Outlook Add-in

To un-install the RC Outlook Add-in, go to **Start Menu → Settings → Control Panel → Add/Remove Programs**. Select the RC Outlook Add-in listed and then click **'Remove'**. The RC Outlook Add-in would be completely un-installed from the system.

## Appendix H: Configure Single Sign-On (SSO) for RC Outlook Add-In

When Resource Central is upgraded to version RC 4.2 HF8, SSO for RC Outlook Add-In is always enabled. Please refer to **RC Outlook Add-In Installation Guide** for more details.

**NOTE:** This function is only applicable for **RC4.2 HF8** onwards.